

COBY

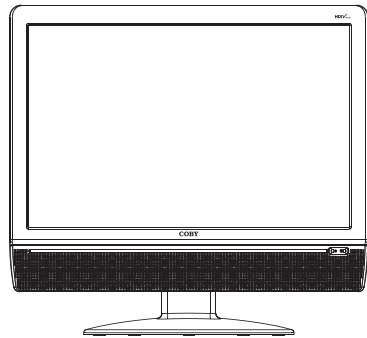

TF-TV1913

Please read this manual before connection and use.

Customer Service Hours

Hours: 800AM-11:00 PM EST, seven days a week.

E-Mail : techsupport@cobyusa.com

Phone: 718-416-3197, 800-681-2629, or 800-727-3592

Web: www.cobyusa.com

English

Important Safety Instruction

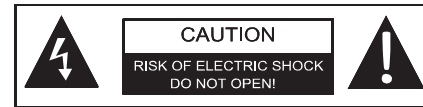

WARNING: TO REDUCE THE RISK OF FIRE OR ELECTRIC SHOCK, DO NOT EXPOSE THIS APPLIANCE TO RAIN OR MOISTURE.



The lightning flash with arrowhead symbol, within an equilateral triangle, is intended to alert the user to the presence of uninsulated "dangerous voltage" within the product's enclosure that may be of sufficient magnitude to constitute a risk of electric to persons.



The exclamation point within an equilateral triangle is intended to alert the user to the presence of important operating and maintenance (servicing) instructions in the literature accompanying the appliance.

CAUTION:

These servicing instructions are for use by qualified service personnel only. To reduce the risk of electric shock, do not perform any servicing other than that contained in the operating instructions unless you are qualified to do so. Refer to manual for servicing instructions.

POWER SUPPLY:

Connect one end of the supplied power cord to the power jack on the unit and the other end to the AC100-240V wall outlet.

POWER MANAGEMENT

Before plugging the power cord into the AC outlet, make sure that all the connections have been properly made.

If the unit will not be used for a long period of time, disconnect the power and remove the batteries from the remote.

Important Safety Instruction

1. Read these instructions.
2. Keep these instructions.
3. Heed all warnings.
4. Follow all instructions.
5. Do not use near water.
6. Clean only with dry cloth.
7. Do not block any ventilation openings. Maintain well ventilated conditions around the product. Do not put product on bed, sofa or anything that blocks ventilation. Install according to instructions.
8. Do not install near any heat sources such as radiators, heat registers, stoves, or other apparatus (including amplifiers) that produce heat.
9. Do not defeat the safety purpose of the polarized or grounding-type plug. A polarized plug has two blades with one wider than the other. If the provided plug does not fit into your outlet, consult an electrician for replacement of the obsolete outlet.
10. Protect the power cord from being walked on or pinched particularly at plugs, convenience receptacles, and the point where they exit from the apparatus.
11. Only use attachments/accessories specified by the manufacturer.
12. Use only with the cart, stand, tripod, bracket, or table specified by the manufacturer, or sold with the apparatus. When a cart is used, use caution when moving the cart/apparatus combination to avoid injury from tip-over.
13. Unplug this apparatus during lightning storms or when unused for long periods of time.
14. Refer all servicing to qualified service personnel. Servicing is required when the apparatus has been damaged in any way, such as power-supply cord or plug is damaged, liquid has been spilled or objects have fallen into the apparatus, the apparatus has been exposed to rain or moisture, does not operate normally, or has been dropped.
15. Apparatus shall not be exposed to dripping or splashing and no objects filled with liquids, such as vases, shall be placed on the apparatus.

Copyright Protection

Unauthorized copying, broadcasting, public performance, and lending of disks are prohibited. This product incorporates copyright protection technology that is protected by method claims of certain U.S. patents and other intellectual property rights owned by Macrovision Corporation and other rights owners. Use of this copyright protection technology must be authorized by Macrovision Corporation, and is intended for home and other limited viewing uses only unless otherwise authorized by Macrovision Corporation. Reverse engineering or disassembly is prohibited.

Table of Contents

Table Of Contents

Important Safety Instruction	
Unpacking	1
Unit View	2
Remote Control	3-4
Cable Connections	5
TV Function	6-9
AV Function	10
PC Function	11
Troubleshooting	12
Specifications	13

Unpacking

Please make sure the following items are included with your LCD TV/monitor. If any items are missing, contact your dealer.

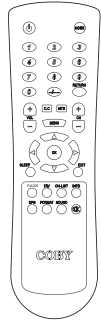

Remote Control

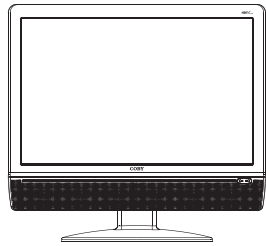

TFT-LCD

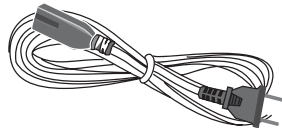

Power Cord

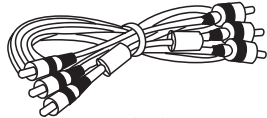

RCA Cable

1

Unit View

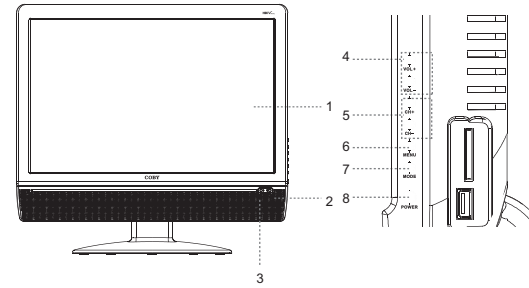

- | | |
|--------------------|----------|
| 1. TFT SCREEN | 5. CH/+ |
| 2. REMOTE SENSOR | 6. MENU |
| 3. POWER INDICATOR | 7. MODE |
| 4. VOLUME-/+ | 8. POWER |

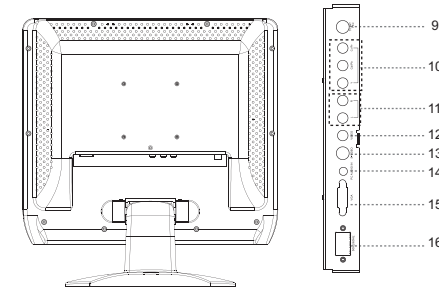

- | | |
|---------------------|-----------------|
| 9. TV ANTENNA | 13. S-VIDEO IN |
| 10. COMPONENT IN | 14. PC AUDIO IN |
| 11. AUDIO IN((R/L)) | 15. VGA IN |
| 12. VIDEO IN | 16. POWER JACK |

2

Remote Control

Remote Control Drawing

1. POWER button
Press to turn the power on/off.
2. CC button
Set the CC mode. (CC on Mute/Off/On).
3. VOLUME +/- button
Press to adjust the volume.
4. MENU button
Press to show the setup menu.
5. SLEEP button
Press to set the sleep timer.
6. MODE button
Press to select the working mode. (TV, AV, S-VIDEO, COMPONENT, PC).
7. RETURN
Press to view the previous channel.
8. MTS
Press to select the TV audio mode.
9. CHANNEL +/- button
Press to skip channels.
10. Direction & OK button
Press the direction buttons to move the cursor.
Press OK to confirm settings.
11. EXIT button
Press to exit the menu setup.
12. Numeric key pad
Press to input data.
13. P.MODE button
Setup the picture mode (Personal, Standard, Soft, Dynamic).
14. FAV button
Press to show the Favorite Channel List. If no channel is set on the list, the button does not function.
15. EPG button
Press to show the Electronic Program Guide.
16. FORMAT button
Press to change the display format as Full, Zoom, Cinema, Letterbox.
17. INFO button
Press to show the current working status.
18. CH-LIST button
Press to show the channel list.
19. MUTE button
Press to muffle/release sound.
20. SOUND button
Press to change the sound mode.

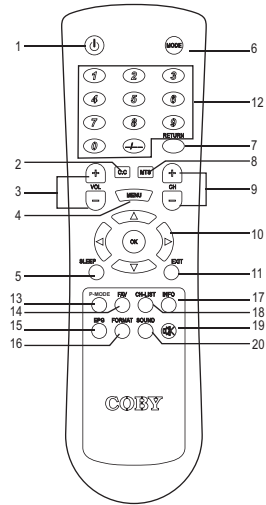

3

Remote Control

Remote Control

Preparation

1. Take off the back cover and insert two AAA batteries and then put on the cover.
Insert the batteries while observing the correct (+) and (-) polarities.
2. Under normal use, the battery will last for six months.

Using Remote control

Point the remote to the remote sensor from no more than 7 meters and within about 60 degrees of the front unit.

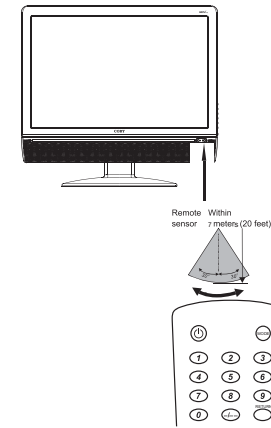

The operating distance may vary depending on the brightness around.

Notes:

- Do not point bright lights directly at the remote control sensor.
- Do not place objects between the remote control unit and the remote control sensor.
- Do not use this remote control unit while simultaneously operating the remote control unit of any other equipment.

4

Cable Connections

Figure. Cable connections

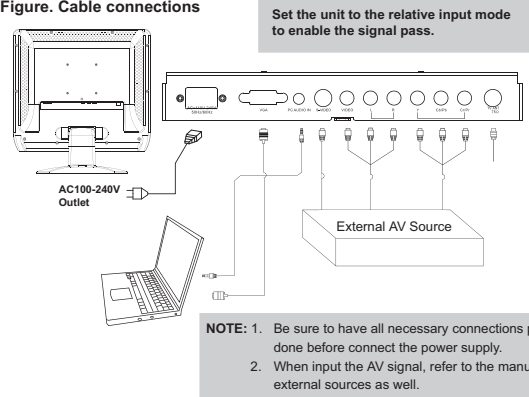

Antenna Connection

Connect TV RF sources to the antenna port. TV RF signals include: receiving antenna/CATV net. You can use 75 Ω coaxial cable to connect outdoor antenna.

AV Signal Input

You can adopt any of the three methods below to input the AV signal.

Defined by the image definition, component input mode ranks first among the three and the S-Video input mode works much better than the RCA mode does.

Component - Connect the YCbCr port by the component cable (not supplied) to input the video signal.

Connect the "L" "R" port to input the audio signal by the white&red plug of the RCA cable.

S-Video - Connect the "S-Video" port by the S-Video cable(not supplied) to input the video signal.

Connect the "L" "R" port to input the audio signal by the white&red plug of the RCA cable.

RCA - - Connect the "Video" port to input the video signal by the yellow plug of the RCA cable.

Connect the "L" "R" port to input the audio signal by the white&red plug of the RCA cable.

VGA Connection (PC Connection)

When used as the computer screen, connect the VGA port by the 15-pin D-SUB signal cable and the PC Audio In port by the audio cable.

Power Connection

Insert one end of the power cord to the power jack on the unit and the other end to the wall outlet with AC100-240V. If the unit will not be used for long period of time, please disconnect the power.

TV Function

TV Function

Preparations

1. Connect the antenna to the antenna jack on the unit side panel.
2. Connect the power supply cord. Press POWER to turn on the the player.
3. Press MODE on the remote to select TV.
4. Press CH+/- buttons to skip channels or press numeric buttons to input channel directly.

Setup Menu

Various features can be preset through the TV setup menu.

TV setup menu consists of six menus. They are Picture Menu, Audio Menu, Time Menu, Option Menu, Lock Menu as well as Channel Menu.

1. Press MENU to show the menu window.
2. Press the left/right button to select the menu, press OK to enter the menu.



Working with menu

While working with the menu,

1. Press the up/down direction button to select the item.
2. Press the left/right direction button to adjust
3. Press MENU to exit.

TV Function

Picture Setup

ITEM	DESCRIPTION
Picture Mode	Setup the picture mode (Personal, Standard, Soft, Dynamic)
Contrast	Adjust the color contrast
Brightness	Adjust the display brightness.
Sharpness	Adjust the display definition.
Tint	Adjust the image color.
Color	Adjust the display color.

Audio Setup

ITEM	DESCRIPTION
Sound Mode	Setup the sound mode as Music, Movie, Personal, Standard.
Bass	Setup the bass effect.
Treble	Setup the treble effect.
Balance	Adjust the sound balance.
Audio Language	Setup the audio language.(English, French, Spanish)

Time Setup

ITEM	DESCRIPTION
Sleep Timer	Setup the sleep timer. (15/30/60/90/120/180/240 Min/Off).
Time Zone	Select the time zone. (Central, Mountain, Pacific, Alaska, Hawaii, Eastern).
Daylight Saving Time	Set the time saving function on/off.

Option Setup

ITEM	DESCRIPTION
OSD Language	Setup the OSD language.
Transparency	Adjust the OSD transparency.
Color Mode	Setup the color mode.
Zoom Mode	Adjust the display mode. (Normal, Zoom, Cinema, 4:3).
Closed Caption	Setup the closed caption type. Refer to "Closed Caption" for details.
Restore Default	Restore settings to the factory default.

TV Function

Option Setup

Closed Caption Setup

Select "Closed Caption" from the Option menu, press OK to enter

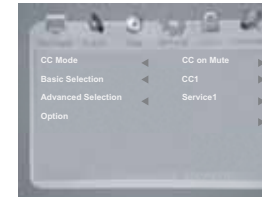

ITEM	DESCRIPTION
CC Mode	Setup the CC mode. (CC On Mute/Off/On)
Basic Selection	Select the basic CC type. (CC1, CC2, CC3, CC4, TEXT1, TEXT2, TEXT3, TEXT4)
Advanced Selection	Select the advanced CC type. (service 1-service 6).
Option	Setup the closed caption type to your own preference. Option - Mode - Default/Custom You can not setup the CC type under the default mode. Select "Custom" to show the CC edit menu.

Lock Setup (Parental Control)

You are required to enter the four digit password to access the lock function.
The initial password is 0000.

After the password is confirmed correct, the screen will display the parental control menu.

ITEM	DESCRIPTION
Change password	Select to change the password. Please remember the password since the system's reset function would not restore the password to the default.
System Lock	Set the system lock function on/off. Set the lock function on to access the parental control setup.
Unrated Lock	Set the unrated lock on/off.
US	Setup the US parental control. TV(TV Rating) - Y, Y7, G, PG, 14, MA. MPAA(Movie Rating) - PG-13, R, NC-17, X, N/A, G, PG) Press the direction buttons to move between options, press OK to set block. To release, press OK again.
Canada	Setup the canada parental control Canada Eng - G, PG, 14+, 18+, E, C, C8+. Canada Fre - E, G, 8ans+, 13ans+, 16ans+, 18ans+.
RRT Setting	Set the rating region table.
Reset RRT	Restore RRT to the default.

TV Function

Channel Setup

ITEM	DESCRIPTION
Antenna	Setup the antenna type as Air or Cable.
Auto Scan	Search channels automatically. Press the right direction button to start searching, press MENU to stop.
Favorite	Make the favorite channels collection. Press the up/down direction button to select the channel, press OK to set. Press OK again to release.
Channel Skip	Skip the unwanted channels. Press the up/down direction button to select the channel, press OK to set. Press OK again to release.
Channel No Channel Label	Edit the channel label. 1. Select "Channel No", press the left/right direction button to select the channel. 2. Select "Channel Label", press the right direction button to show the edit menu. In the menu, press the left/right direction button to move left/right, Press the up/down direction button to make changes.
DTV Signal	Display the DTV signal information.

AV Function

AV Function

The player has AV input functions. You can enjoy programs from external input sources. Connect the external AV signal source to VIDEO or S-VIDEO jack, and then turn on the player and press the MODE button to select the AV input mode. (AV, S-VIDEO, COMPONENT).

Setup Menu

Various features can be preset through the AV setup menu. AV setup menu consists of five menus. They are Picture Menu, Audio Menu, Time Menu, Option Menu as well as Lock Menu.

1. Press MENU to show the menu window.
2. Press the left/right direction button to select the menu, press OK to enter the menu.



Working with menu

While working with the menu,

1. Press the up/down direction button to select the item.
2. Press the left/right direction button to adjust
3. Press MENU to exit.

Note: Refer to the TV section for details on Picture Setup , Audio Setup, Time Setup, Option Setup as well as Lock Setup.

PC Function

PC Function

You can use the unit's TFT LCD as your computer's monitor.

1. Shut down the unit and the computer. Connect the unit to the computer VGA jack by the VGA cable.
2. Turn on the player and the computer. If the unit is in the standby mode, press POWER button to switch on. Press the MODE button to select the "PC" mode.

Setup Menu

Various features can be preset through the PC setup menu.

PC setup menu consists of four menus. They are Picture Menu, Audio Menu, Time Menu as well as Option Menu

1. Press MENU to show the menu window.
2. Press the left/right direction button to select the menu, press OK to enter the menu.



Working with menu

While working with the menu,

1. Press the up/down direction button to select the item.
2. Press the left/right direction button to adjust
3. Press MENU to exit.

Note: Refer to the TV section for details on Picture Setup , Audio Setup, Time Setup as well as Option Setup.

Adjust the PC Screen

Upon switching to the PC mode, the monitor will be automatically regulated for a proper functioning. If the result is not up to your expectation, please perform the following steps to adjust the screen manually .

1. Select "Auto" under the "PC Setup Menu" and press the right direction button to start modulation. (Option Menu --> PC Setup Menu --> Auto)
2. Or if you still have problem with the monitor after, adjust "H-Position", "V-Position", "Clock " as well as "Phase" accordingly under the PC Setup menu.

Trouble Shooting

Symptom	Check and Action
No power	<ul style="list-style-type: none"> • Make sure the unit has been powered on manually. • Check if the power cord has been properly connected to the power outlet. • Check if the main power has been switched on.
No picture	<ul style="list-style-type: none"> • Try another TV channel • Check if the system connection is proper and secure. • Check if the connection cables are damaged.
No sound	<ul style="list-style-type: none"> • Increase the volume. • Check if the MUTE function of the unit has been activated. • Check if the sound system has been properly set. • Check if the AV audio signal input cable has been connected properly.
Color distorted	<ul style="list-style-type: none"> • Reset the color system of the unit. • Check if the system has been properly connected. • Check if the AV video signal input cable is connected properly.
Picture and sound are interfered	<ul style="list-style-type: none"> • Check if the system has been properly connected. • If using antenna, adjust the antenna.
Remote control does not work	<ul style="list-style-type: none"> • Make sure the POWER button on the unit has been turned on manually. • Remove the obstacles between the remote control and the player. • Point the remote control towards the remote sensor on the player. • Check if the batteries of the remote control have been loaded with correct polarities. • Replace the batteries of the remote control.
Malfunction	<ul style="list-style-type: none"> • Should the player develop a malfunction, unplug the player for 30 minutes. After that, power on the player and the restore function should reset the player.

Specification

TFT Panel characteristic	Size	19"		
	Resolution	1440X900		
	Pixel pitch	0.297(H)x0.294(V)mm		
	TV system	NTSC 3.58/4.43 (VIDEO IN)		
TV characteristic	Channel received	VHF-L	54.25-160.25MHz	
		VHF-H	166.25-463.25MHz	
		UHF	469.25-863.25MHz	
	Intermediate frequencies	Picture IF	45.75MHz	
		Color	42.17MHz	
		Sound	41.75MHz	
	Scanning	Horizontal	15750Hz	
		Vertical	60Hz	
Antenna impedance	75Ω,unbalance			
Tuning system	FS with PLL			
Standard	Power consumption	AC input	100-240V 50/60Hz	
		On working	40W (Max)	
		Standing	<2W	
		Speaker	2x (4 Ω, 5W)	
	Operating temperature range	10 °c-40 °c		
Dimension	460x59x423 mm			
Weight	5302g			
DTV characteristic	DTV system	ATSC/QAM		
	Channel received	VHF-L ch.2 to B (57 to 129MHz) VHF-H ch. C to K(135 to 363 MHz) UHF ch. LL to 69 (369 to803 MHz)		
	Intermediate frequencies	Center IF : 44 MHz f1 : 46.69 MHz f2: 41.31MHz		

Design, specifications and manual are subject to change without prior notice.